

Microstrip RFID Antenna Design at 5.1 GHz

T.J. Korfiati^a, E.A. Karagianni^b, A.T. Arapoyianni^a, C.N. Vazouras^b, A.D. Tsigopoulos^b

^a National and Kapodistrian University of Athens

^b Hellenic Naval Academy

Abstract. A design of a microstrip tag antenna with a configurable design is introduced for the C frequency band. The coupling between the microstrip lines is achieved by reducing the distance between the lines. The tag antenna has a good impedance input matching with -20.016dB return loss at 5.1 GHz.

Keywords: Antennas; Coupled lines; Microstrip lines; RFID; Spiral Antenna; Tag

1. INTRODUCTION

Radio Frequency Identification (RFID) is currently one of the most promising and discussed auto-identification and data capture technologies. Although it is not a new technology it has become a mainstream and remains in the front end of the general research and development sector concerning the remotely receiving and transmitting data using RF waves. In the ultra-high frequencies (UHF) band there are many applications in which an RFID antenna can be used, such as object identification, access control, satellite communication, millimeter wave wireless technologies. A RFID system consists of three parts namely reader, tag and the data processing system [1], [2]. One of the notable challenges in RFID technologies is the small-sized tag antennas design with high impedance matching for IC chips. So, in this paper we focus on the tag antenna RFID and a design of a microstrip RFID antenna is presented. A microstrip line has become the best known and most widely used planar transmission line for RF and Microwave circuits. In simple terms, microstrip is a printed circuit version of a wire over a ground plane, and thus it tends to radiate as the spacing between the ground plane and the strip increases [3]. Coupled microstrip lines are formed by two transmission lines which are positioned parallel to each other, as it is presented in Figure 1. In such a unit there is a continuous coupling between the lines because of the presence of electromagnetic field. The coupled lines are used widely as key elements of direction couplers, filters and a variety of electronic circuits. Because of the coupling of electromagnetic fields, a pair of coupled lines can support two different modes [4], [5].

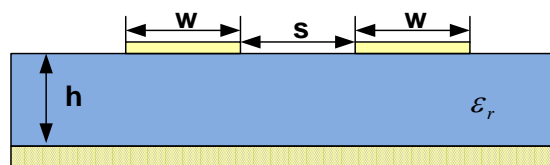

FIGURE 1. Coupled Microstrip Lines

2. ANTENNA DESIGN

A pair of equal width microstrip lines is presented in Figure 2 labeled as 1 and 2 for each strip line, with constant spacing between them. The characteristic impedance Z_0 is defined by the self-inductance L_{11} , and self-capacitance C_{11} with respect to the ground, in the case that the voltages in the conductors are equal. If spacing between the transmission lines is decreased, there will be electromagnetic coupling, which is defined by the mutual inductance L_{12} and mutual capacitance C_{12} . Also, in Figure 2 the physical interpretation of equivalent capacitances of odd mode is represented. The odd mode corresponds to an antisymmetric stimulation (the even mode has symmetric stimulation) which means that the voltages of the two microstrips lines are equal and opposite. Also we have capacitances that are the result of edge phenomenon and capacitances of adjacency. It is important to note that the capacitances of adjacency are appearing because of the odd mode [5], [6].

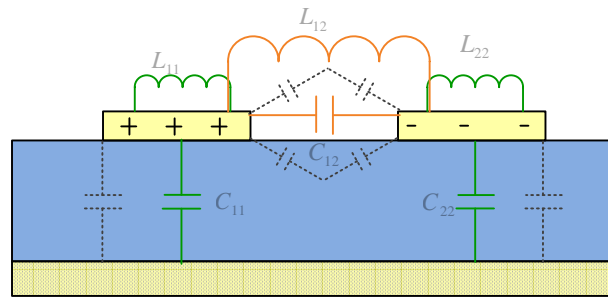

FIGURE 2. Coupled Microstrip Lines with capacitances.

The characteristic impedances Z_{ce} for even and Z_{co} for odd mode can be obtain from the following equations (1), (2) [6].

$$Z_{ce} = \left(c \cdot \sqrt{C_e^a \cdot C_e} \right)^{-1} \quad (1)$$

$$Z_{co} = \left(c \cdot \sqrt{C_o^a \cdot C_o} \right)^{-1} \quad (2)$$

$$C_e = C_p + C_f + C_f' \quad (3)$$

$$C_o = C_p + C_f + C_{gd} + C_{ga} \quad (4)$$

$$C^a = \epsilon / h \quad (5)$$

Where C_o , C_e are the even and odd mode capacitance, C_a is capacitance for air dielectric (ϵ is dielectric constant of the material and h thickness of the material), C_p is the parallel capacitance between strip and ground plane, C_f is the fringe capacitance, C_f' is the modification of fringe capacitance C_f of a single line due the presence of another line, C_{gd} and C_{ga} are the adjacency capacitance [6].

Selecting rectangular spiral shape to implement the tag antenna was the fact that, as the dimensions are minimized, result is saving space. Hence, the spiral shape ensures antenna small dimensions while the total line length is adequate to achieve antenna resonance at the desire frequency.

The design consists of a coil with a given number of turns and a given size. The tag has two layers. The first one consists of GaAs dielectric and the second of copper with a given thickness,

also. Although the length, the width, the thickness and the space between the copper strips and the thickness of the dielectric layer have been created with specific dimensions initially, they all could be changed so that our design can be parameterized for any value under specific limitations. Figure 4 represents the initial RFID design with the configurable size parameters. The total size is initially equal to $x_0 \cdot y_0 = 35 \times 35 \text{ mm}^2$. The microstrip line is of $x = 1.5 \text{ mm}$ width. The thickness of copper is $b_{\text{cop}} = 0.04 \text{ mm}$ and the space between lines is $s = 0.5 \text{ mm}$. Also, $b_{\text{sp}} = 0.18 \text{ mm}$, $b_{\text{sub}} = 0.32 \text{ mm}$ is the substrate thickness, those variables representing in a layout view in Figure (3a). The space between strip line 5 and strip line 1 as represent in Figure (3b) is $k = 7 \text{ mm}$.

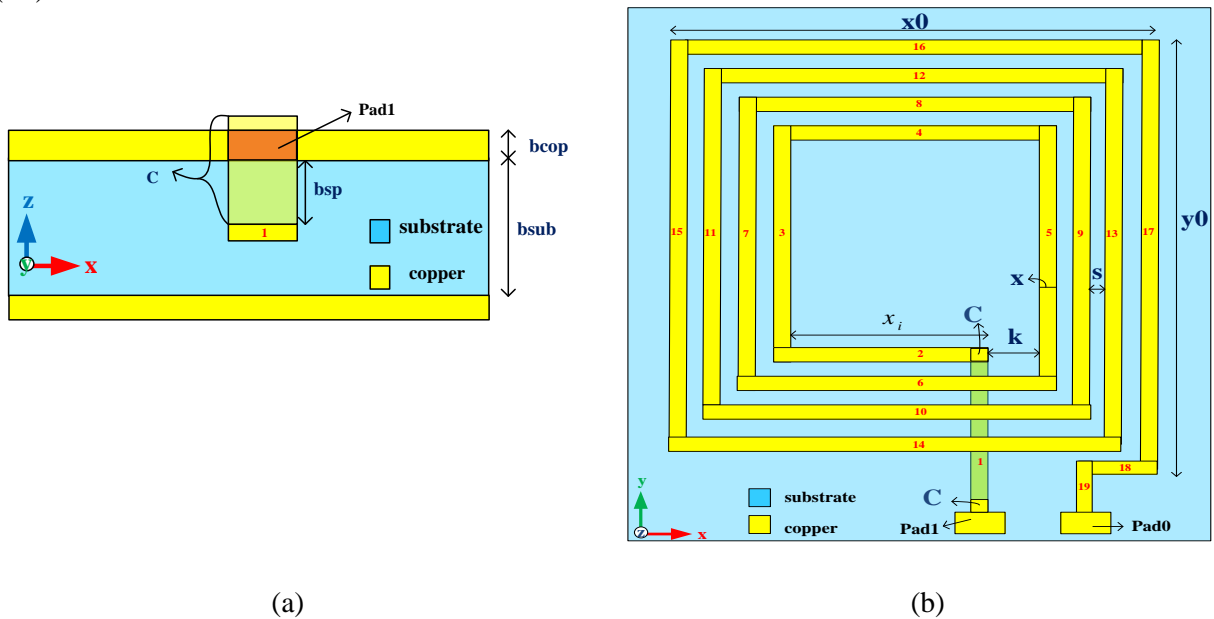

FIGURE 3. (a) Variable representation at the z,x view, (b) RFID design

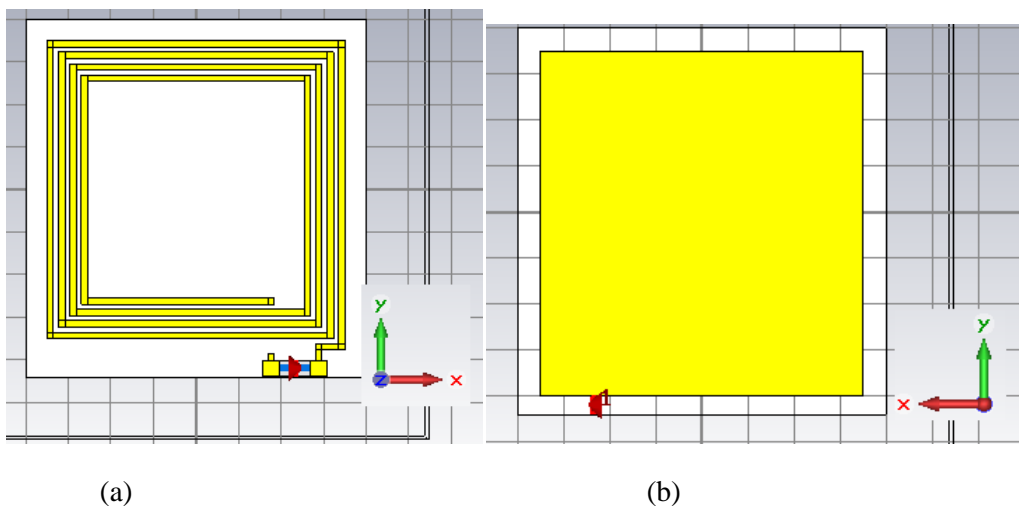

FIGURE 4. RFID design in CST Studio (a) front area of RFID, (b) back area of RFID

The reactance of the coil for resonance frequency F is given by the following equation (6).

$$X_L = 2 \pi F L \quad (6)$$

Considering that the circular shaped inductor and the square shaped inductor have equivalent model equations regarding x , s , x_0 , y_0 (6), (7), (8), we can use the equation (7) to calculate the inductance L for the square spiral inductor with n number of turns,

$$L(nH) = 0.03937 \cdot \frac{a^2 \cdot n^2}{8 \cdot a + 11 \cdot c} \cdot K_g \quad (7)$$

K_g is a correction factor depended on the ratio w/h . In our case where $x/b_{sub} > 0.05$ the K_g is given by (10), and a and c given by (8) and (9) respectively.

$$a = \frac{x_0 + x_i}{4} = \frac{x_0 + y_0 - 4 \cdot x - 3 \cdot s - k}{4} \quad (8)$$

$$c = \frac{x_0 - x_i}{2} = \frac{x_0 - (y_0 - 4 \cdot x - 3 \cdot s - k)}{2} \quad (9)$$

$$K_g = 0.057 - 0.145 \cdot \ln\left(\frac{x}{b_{sub}}\right) \quad (10)$$

With the above equations (6), (7) if we change the parameters b_{cop} , s and x the behavior of this antenna will be changed regarding matching, coupling and resonance frequency.

3. SIMULATION RESULTS

In this section the results of simulations of the tag design, by using the CST Studio are presented. Figure 5 represents the results of the input reflection coefficient S_{11} with the parameter B_{sub} ranging from $B_{sub} = 0.32\text{mm}$ to $B_{sub} = 64\text{mm}$, while all the other parameters remain constant. Notice that the substrate material is GaAs at this antenna design. At this point, according to the results, it is should be noted, that the changes in substrate thickness affect the S_{11} value over frequency. So, with that result we can optimize the antenna to the desired frequency. A passive RFID tag antenna with the minimum space between the microstrip lines $s = 1.2\text{mm}$, the maximum line's width $x = 1.5\text{mm}$, the maximum occupied area $x_0 \cdot y_0 = 35\text{mm}^2$. The S_{11} has a very good value of -20.016 dB at 5.103GHz . The value of s parameter was chosen to be that it is, as result the best gain and S_{11} .

TABLE 1. Parameters of the design and results of the antenna

Parameters	(mm)
Bcop	0.04
Bsp	018
Bsub	0.72
K	7
S	1.2
X	1.5
X0	35
Y0	35
S11 (dB)	-20.016
Gain (dBi)	1.286
Directivity (dB)	5.217

S11 values in conjunction with gain and directivity values at 5.1GHz are represented in Table 1. Respectively we have a 1.286 dB gain, 5.217 dBi directivity, with these two values we can get the efficiency of the antenna $n = 0.24$ or 24% ($n = \text{Gain}/\text{Directivity}$).

Table 2 shows the comparison between the various parameters of antenna i.e. dimensions, substrate material, gain. It can be easily seen that the proposed antenna is a good candidate as with GaAs substrate can support IC. Also can take place in WLAN applications.

TABLE 2. Comparison of proposed antenna to previously reported antenna

Ref.	Dimensions (mm)	Frequency (GHz)	Substrate	Gain(dBi)
[12]	40.4 x 37.8	5.1	FR-4	0.65-1.91
[13]	10 x 13	5.1 - 5.5	FR-4	0-2.09
[14]	32 x 36	5.65 – 6.7	FR-4	1.72
Proposed Antenna	35 x 35	5.1	GaAs	1.286

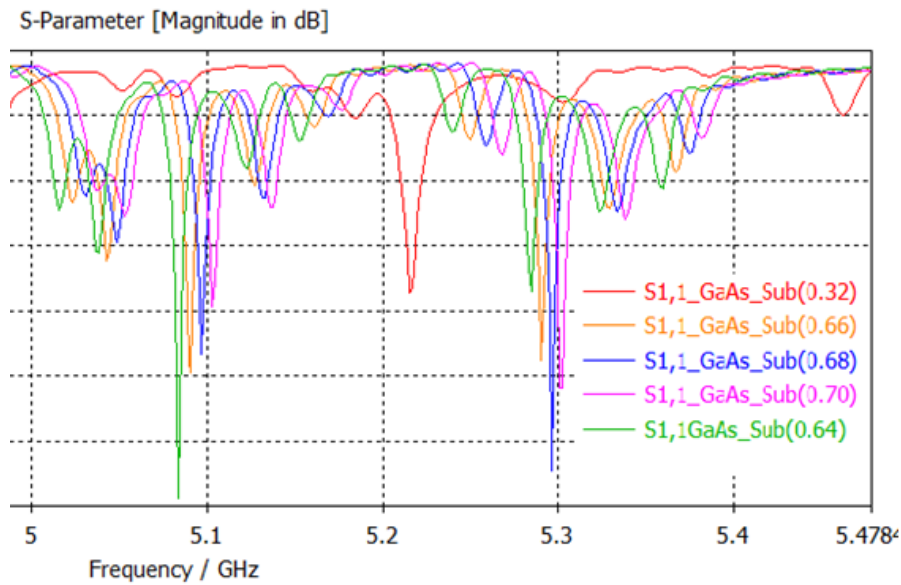

FIGURE 5. Simulation Results S11, with Bsub varied from Bsub = 0.32mm to Bsub = 64mm

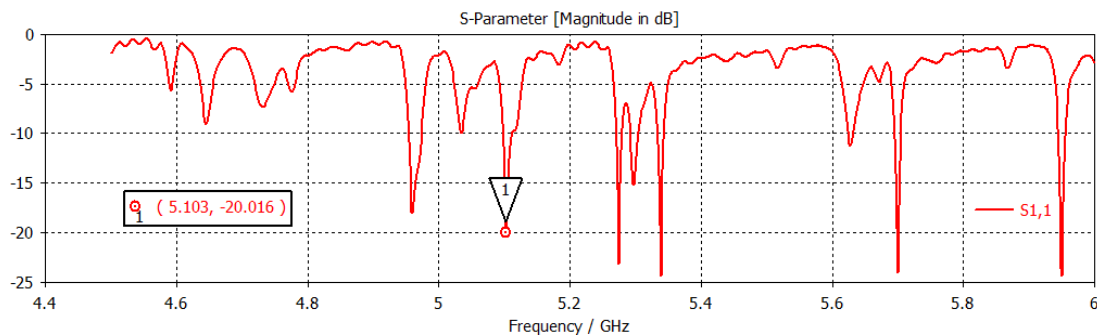

FIGURE 6. Simulation Results S11, at 5.1GHz

5. CONCLUSIONS

A RFID microstrip antenna that operates at the C frequency band has been introduced. In order to investigate and achieve optimum dimensions over the desire frequency range, the design has been parameterized having the flexibility in changing its dimensions. CST software has been used for analytical modelling and simulation. A balanced passive C-band RFID tag antenna with the minimum distance between the microstrip lines $s = 1.2\text{mm}$, the maximum line's width $x = 1.5\text{mm}$, the maximum occupied area $x_0*y_0 = 35\text{mm}^2$, is presented in Figure 7. It resonates at frequency 5.103GHz having a very good value of S11 as presented in Figure 8. The proposed RFID tag antenna has an impedance of $48.378-j15.42 \Omega$ at 5.1GHz . A S11 of -20.016 dB is achieved at this frequency. 3D antenna radiation pattern is represent in Figure 9. The antenna gain is 1.286 dB , the directivity is 5.217 dBi and the efficiency of the antenna is $\eta = 0.24$ or 24% . In the chosen frequency band 5.1 GHz , witch is include in range 5.15 to 5.35 GHz , can be used for IEEE 802.11A Wi-Fi wireless computer networks [15]. Future work could focus to the optimization of the efficiency of antenna, so that a very good performance is achieved at the desired frequency.

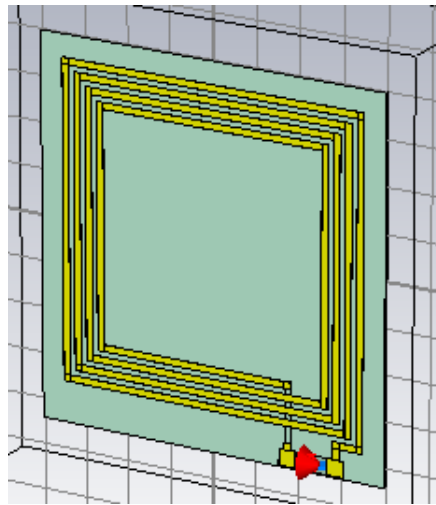

FIGURE 7. RFID Antenna

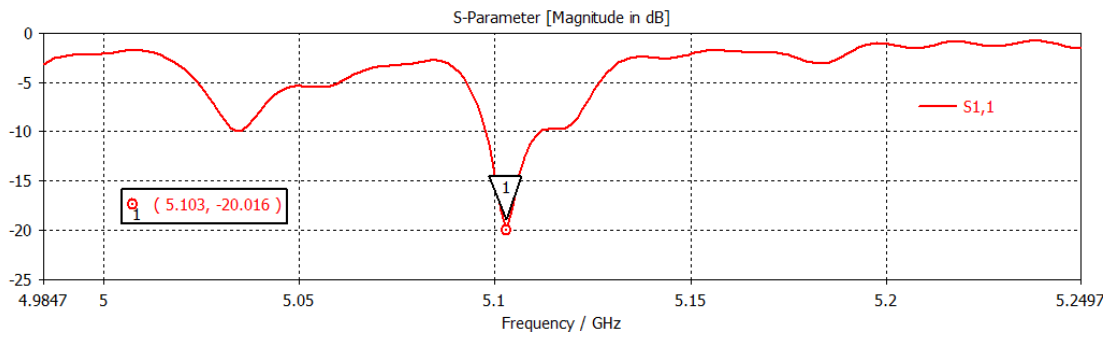

FIGURE 8. Simulation Results S11, at 5.1GHz

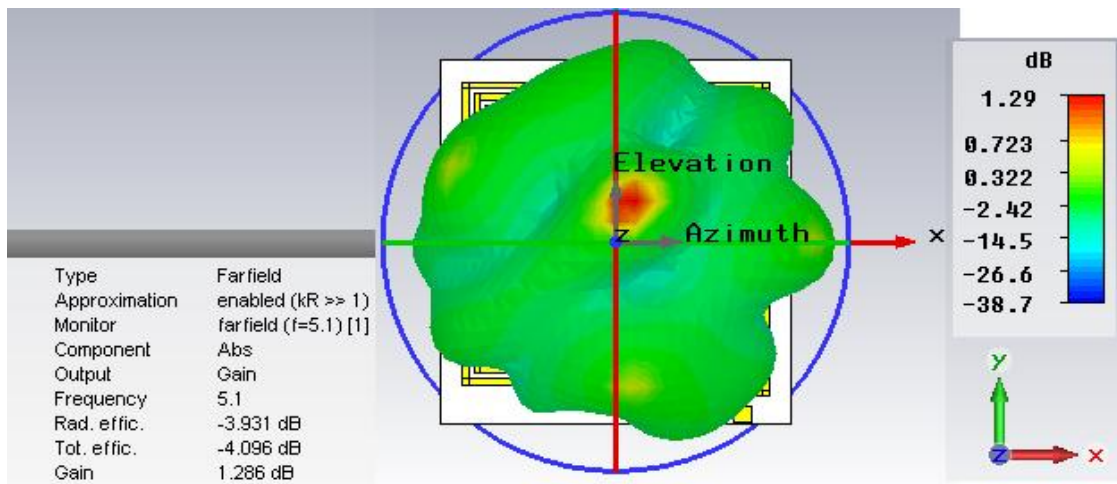

FIGURE 9. 3D Radiation Pattern at 5.1GHz in CST Studio

REFERENCES

1. Huy Hung Tran, Ikmo Park "Compact Crossed Dipole Antenna for a Broadband UHF-RFID Tag", IEEE Antenna Technology (iWAT), 2015 International Workshop on.
2. Sotirios K. Goudos, Katherine Siakavara, John N. Sahalos, Life Fellow, IEEE "Novel Spiral Antenna Design Using Artificial Bee Colony Optimization for UHF RFID Applications", IEEE Antennas and Wireless Propagation Letters Vol. 13, 2014.
3. Iulian Rosu, "Microstrip, Stripline, and CPW Design", <http://www.qsl.net/va3iul/>.
4. Constandine A. Balanis, "Antennas Analysis and Design", 2005.
5. K. C. Gupta, R. Garg, I. Bahl, and P. Bhartia, "Microstrip Lines and Slotlines", Boston, Artech House, 1996.
6. Jia-Sheng Hong, M.J.Lancaster, "Microstrip Filters for RF Microwave Applications", John Wiley and Sons, 2001.
7. "RFID Radio Frequency Identification", OECD Ministerial Meeting on the Future of the Internet Economy, 2008.
8. Ramiro A. Ramirez and Thomas M. Weller, "Dielectric-Loaded End-Fire Slot Antenna With Low Back-Lobe Radiation for UHF RFID Applications", International Workshop on Antenna Technology (iWAT), 2016
9. Tingqiang Wu, Hua Su, Liyun Gan, Huizhu Chen, Jingyao Huang, and Huaiwu Zhang, "A Compact and Broadband Microstrip Stacked Patch Antenna With Circular Polarization for 2.45-GHz Mobile RFID Reader", IEEE Antennas and Wireless Propagation Letters, Vol. 12, 2013.
10. Jinxi Chen and Sungkyun Lim, "An Unbalanced, Electrically Small Tag Antenna for Passive UHF RFID", SoutheastCon IEEE Conference, 2016.
11. Li Yang, Amin Rida, Rushi Vyas, Manos M. Tentzeris "RFID Tag and RF Structures on a Paper Substrate Using Inkjet-Printing Technology", IEEE Transactions on Microwave Theory and Technoques, Vol. 55, No. 12, 2011.
12. Kumar, P., Dwari, S., Saini, R. K., & Mandal, M. K. (2018). "Dual-Band Dual-Sense Polarization Reconfigurable Circularly Polarized Antenna". IEEE Antennas and Wireless Propagation Letters.
13. Keshwala, U., Rawat, S., Ray, K., Nair, N., & Yadav, S. (2018). "Compact circular monopole antenna with band notch characteristics for UWB applications ". 2018 5th International Conference on Signal Processing and Integrated Networks (SPIN).
14. Praveen Kumar Rao, Rajan Mishra (2018). "Multi Band Antenna with Multi Band Notch2.5/3.7/6.4/8.1/12.4/14.4GHz Characteristics". (2018) 5th IEEE Uttar Pradesh Section International Conference on Electrical, Electronics and Computer Engineering (UPCON).
15. [https://en.wikipedia.org/wiki/C_band_\(IEEE\)](https://en.wikipedia.org/wiki/C_band_(IEEE))